

Load direction
加载方向

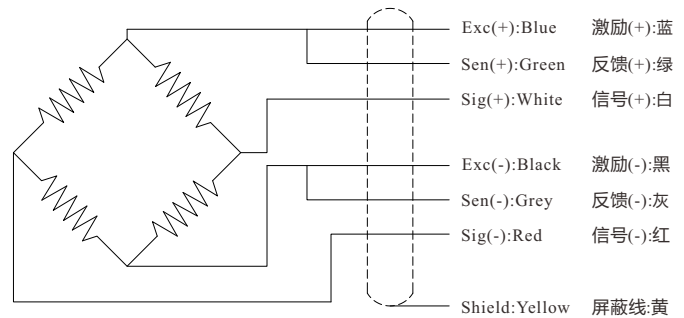

Wiring Diagram/接线图



Capacity(kg)	A	B
5/10/20/50/ 100/200	8.2	8.2
500	11.1	10.5

--- Specifications / 规格参数 ---

Capacity/量程	5/10/20/50/100/200/500kg		
Rated Output 额定输出	2.0±0.01mV/V	Compensated Temp. 温度补偿范围	-10...+40°C
Excitation 激励电压	5~15V	Operating Temp. 工作温度范围	-20...+60°C
Zero Balance 零点输出	±2% of R.O.	Temp. Shift Zero 零点温度漂移	±0.015% of R.O./10°C
Nonlinearity 非线性	±0.015% of R.O.	Temp. Shift Span 灵敏度温度漂移	±0.015% of R.O./10°C
Hysteresis 滞后	±0.015% of R.O.	Input Resistance 输入阻抗	390±5Ω
Nonrepeatability 非重复性	±0.01% of R.O.	Output Resistance 输出阻抗	350±5Ω
Creep(30min) 蠕变	±0.015% of R.O.	Insulation Resistance 绝缘阻抗	>5000MΩ(50V)
Safe Overload 安全过载	150% of F.S.	Ingress Protection 防护等级	IP68
Ultimate Overload 极限过载	200% of F.S.	Material of Element 弹性体材料	Stainless steel 不锈钢
Cable 导线	Ø5.3*3000mm 6-core shielded cable Ø5.3*3000mm 6芯屏蔽线		
R.O.=Rated Output/额定输出 F.S.=Full Scale/满量程			

• Subject to change without notice / 如有更改,不另行通知